

Drop**safe**[®]



Drops Prevention Technology

Catalogue



Professional.
Reliable.
Secure.

dropsafe.com



About Us

Dropsafe: Your global Drops Prevention Partner

Dropsafe creates solutions to prevent objects falling from height, and we are your global partner in drops prevention. We offer the tools, advice and resources you need to tackle drops risks comprehensively, sustainably, and in a cost-effective manner.

Ensuring personnel safety is paramount. By creating a safer workplace you can not only protect your people but comply with industry best practice. As leaders in drops prevention, Dropsafe strives to help companies achieve an unparalleled level of safety. We can support you by providing the highest-quality drops prevention solutions, enabling you to set a new benchmark of industry safety.

All Dropsafe systems have been designed to be assets rather than consumables. With a focus on low-cost, long term ownership, we manufacture high-quality products to help eliminate the dangers personnel are exposed to from falling objects.

We aim to educate companies around the risks dropped objects pose through handbooks, articles and industry updates, to promote a safety culture that goes beyond our technologies. We want facility personnel to be aware of the threat dropped objects pose, ensuring teams know the dangers, and also positive and effective mitigation strategies.

Dropped Object Hazards

Fixtures, handheld devices, unsecured tools, loose items and structural components that may fall from height are all potential safety hazards.

Dropped objects from overhead can cause serious injury, fatalities and damage to critical equipment.

A wide range of factors contribute to dropped objects:

- Improper Risk Assessment
- Human Factors
- Inadequate Procedures
- Poor Housekeeping
- Inadequately Stored & Managed Tools or Equipment
- Failed Fixtures & Fittings
- Insufficient Inspection, Repair & Maintenance
- Environmental Factors

Industry leaders and organisations have recognized the importance of dropped object prevention solutions.

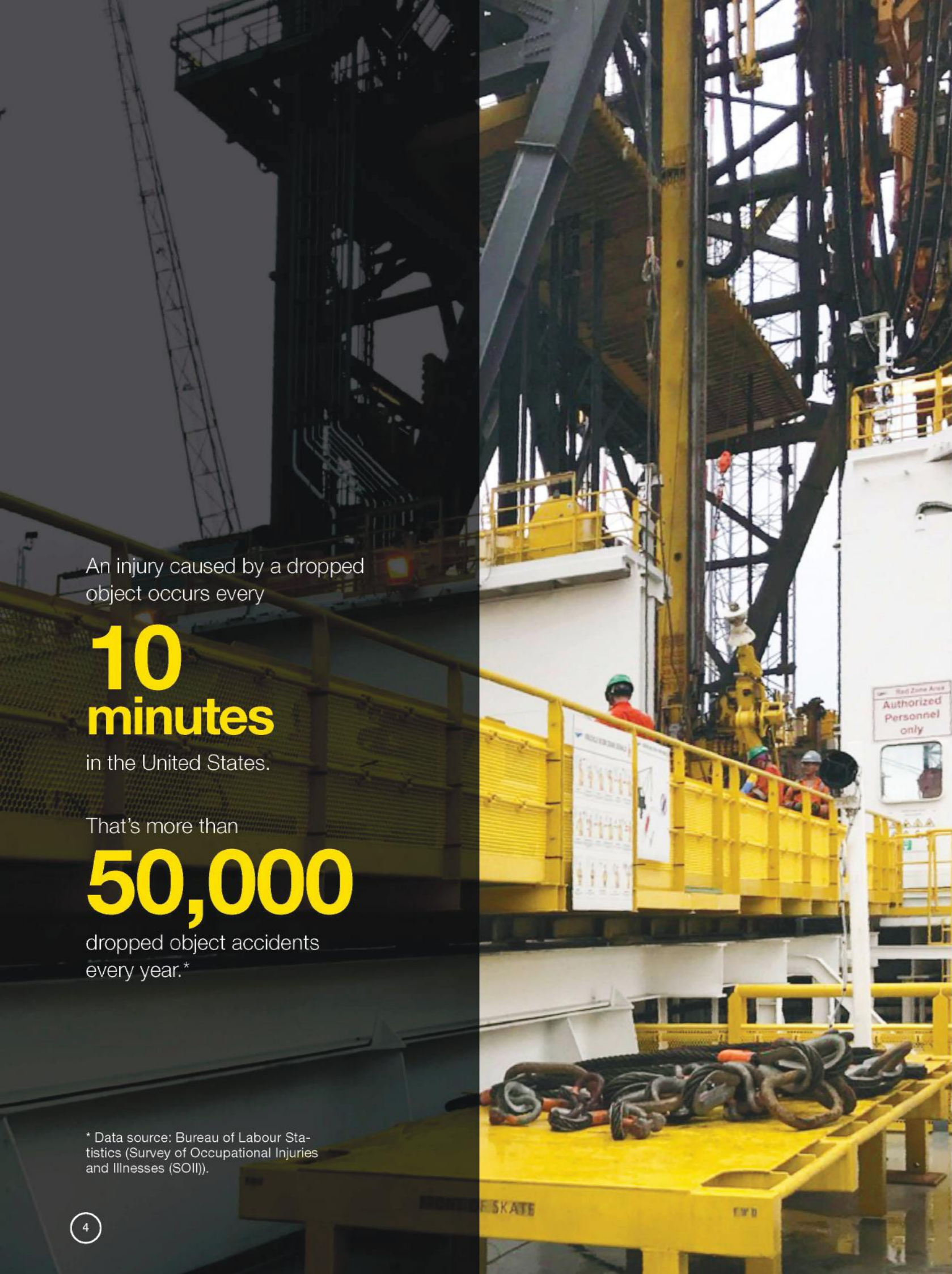

An injury caused by a dropped object occurs every

10 minutes

in the United States.

That's more than

50,000

dropped object accidents every year.*

* Data source: Bureau of Labour Statistics (Survey of Occupational Injuries and Illnesses (SOII)).

Our Products

Dropsafe Drops Prevention products have become the industry standard. We focus on innovation, quality, industry collaboration and 3rd party testing and validation in order to deliver product performance that exceeds customer expectations. We maintain a leading industry-wide quality record, supported by rigorous in-house procedures and state-of-the-art manufacturing control and monitoring technology.

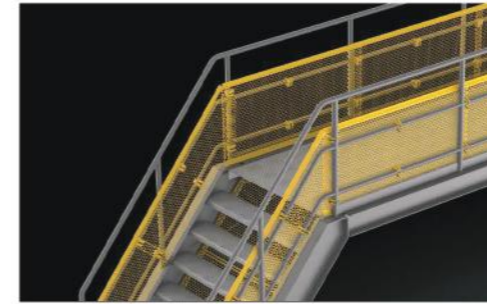

Barrier

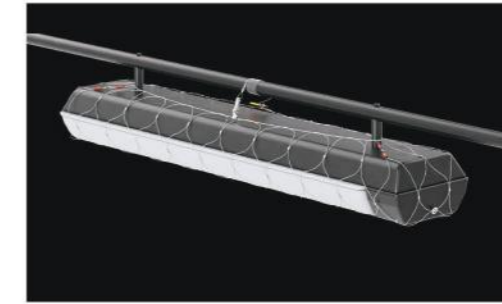

Nets



Slings

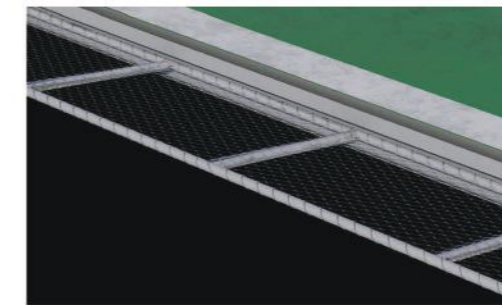

Helideck Net



Tool Tethering

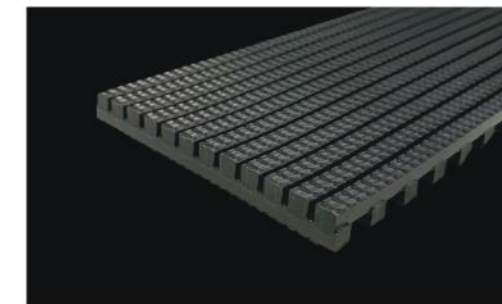

Matting

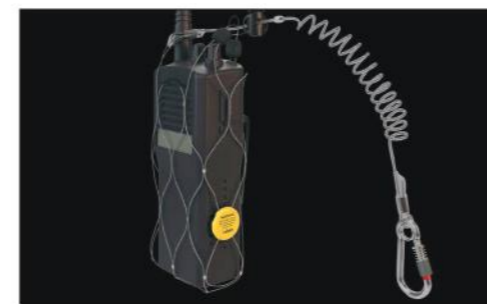

Pouches



Barricade

Dropsafe Barrier

The Dropsafe Barrier is a dropped object prevention system, that reduces the risk of harm to people and critical equipment caused by items falling from height.

The system is attached to the inside of elevated guardrailing of permanent and temporary installations. This prevents loose dynamic items from becoming dropped objects.

The system can also be used as a physical barrier between personnel and operating machinery to significantly improve work place safety.

Benefits

- Closes the gap in human error
- Instant safety solution compliant with international standards
- Fast & easy installation with minimal tools and no hot works
- Maintenance & corrosion free
- Reusable & recyclable, reducing industrial waste

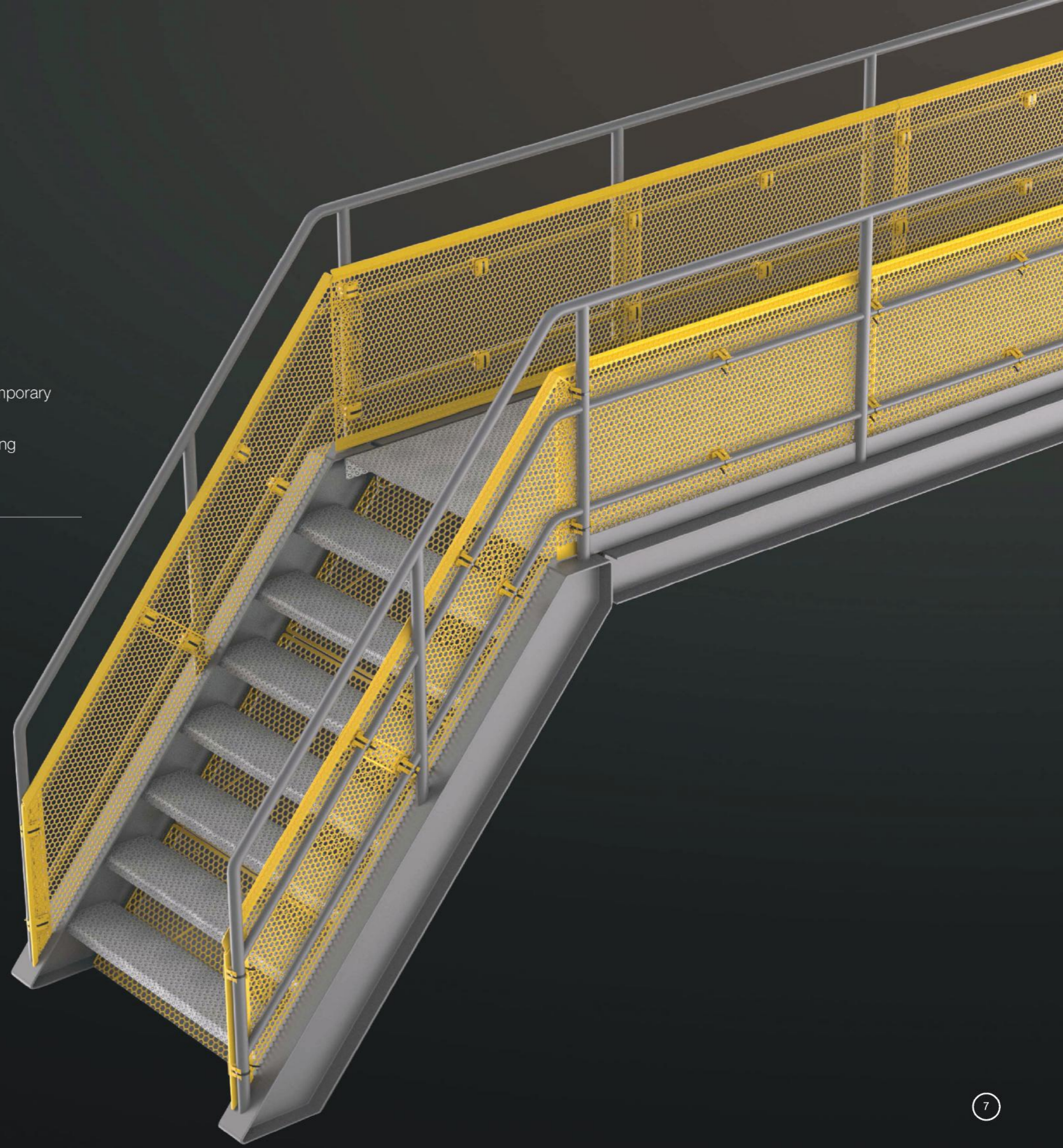



How The Dropsafe Barrier Works

When work is taking place at height, items such as tools, hard hats, handheld and maintenance equipment can fall through open guardrailing on walkways, stairways, scaffolding, and elevated work platforms.

The Dropsafe Barrier is a modular system, consisting of impact resistant panels with a small honeycomb aperture. The versatile barrier panels are fast and easy to install, attaching along the inside of the guardrailing or under stairs using a universal attaching system.

Robust, long-lasting, reusable and recyclable, the Dropsafe Barrier system is a cost-effective, long-term solution to mitigate the potential risks of dropped or falling objects.

Features



Suitable for harsh environments



High impact resistance



Designed for high winds
250km/h (155mph)



Small aperture 19.8mm (0.78")



Lightweight system



Fire and chemical resistant



10+ year service life



ABS DOPPP+ approved

Installation locations

The Dropsafe Barrier is designed and tested to install in a variety of locations.



Walkways



Stairways



Temporary Structures

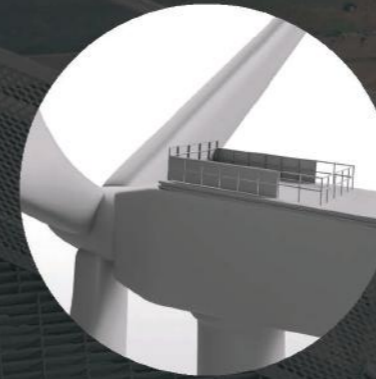

Wind Turbine Nacelles



Conveyor Walkways



Storage Areas

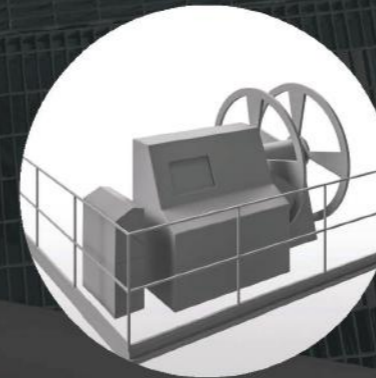

Machine Guards



Cherry Pickers



Power Boilers

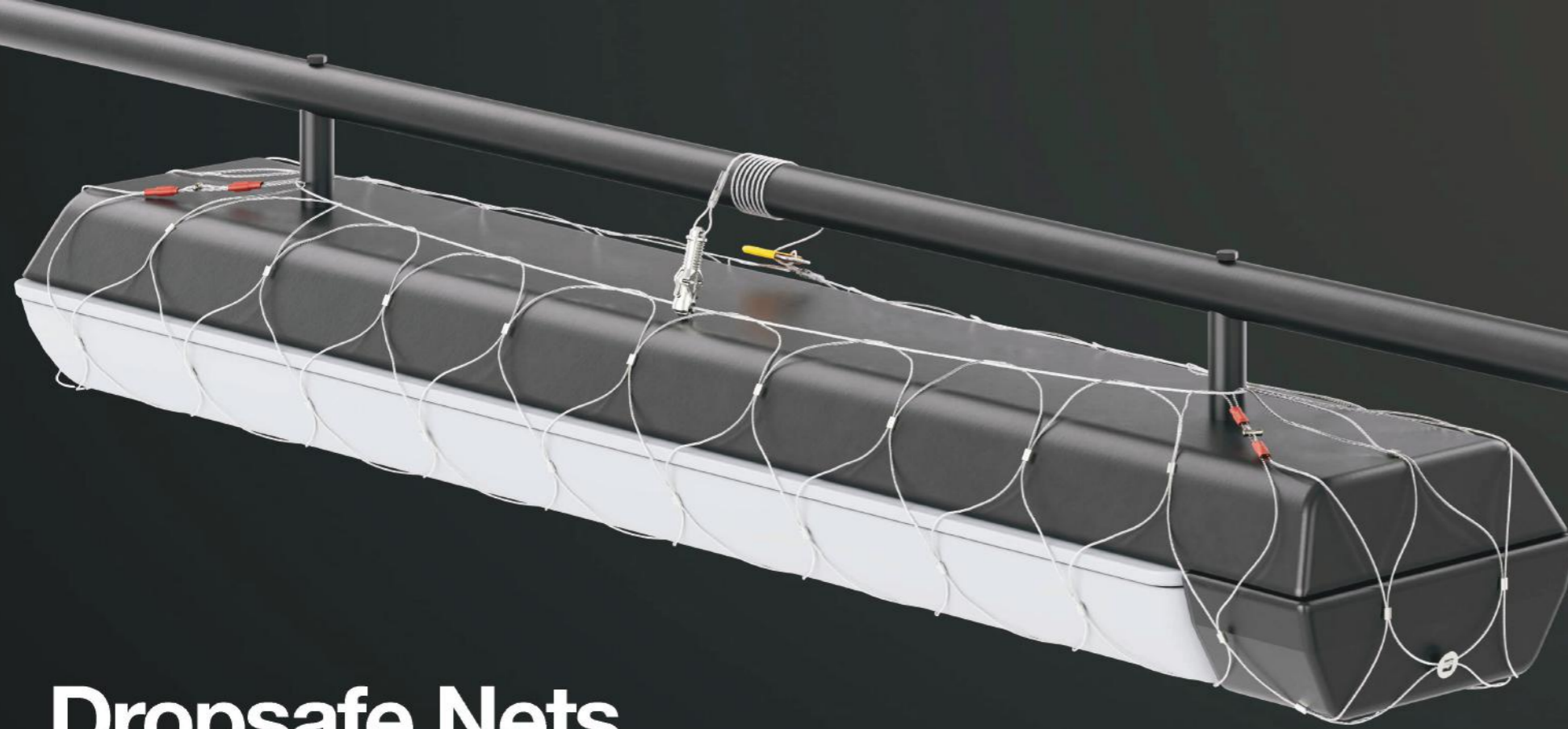

Dropsafe Nets

Dropsafe Nets have always delivered the highest standard of secondary retention for fixtures at height. The new Dropsafe Nets are an evolution of the existing range, with additional features, such as the Trisafe™ Carabiner and RFID Choke Plate, to further increase safety and mitigate the risks dropped objects pose to personnel.

The new Dropsafe Nets are tested and certified to over 5x the Safe Working Load. With more than 100 sizes and installation toggles to ensure a snug fit, the Nets are all made from SUS 316 stainless steel. These features and the additional enhancements set a new safety standard for drops prevention.

Benefits

- Provides an instant safety solution for your personnel
- Easy to install, no tools required
- Fully encloses and tethers fixture being secured
- Retains loose or dislodged items
- Available for a wide range of fixture types
- Fully recyclable

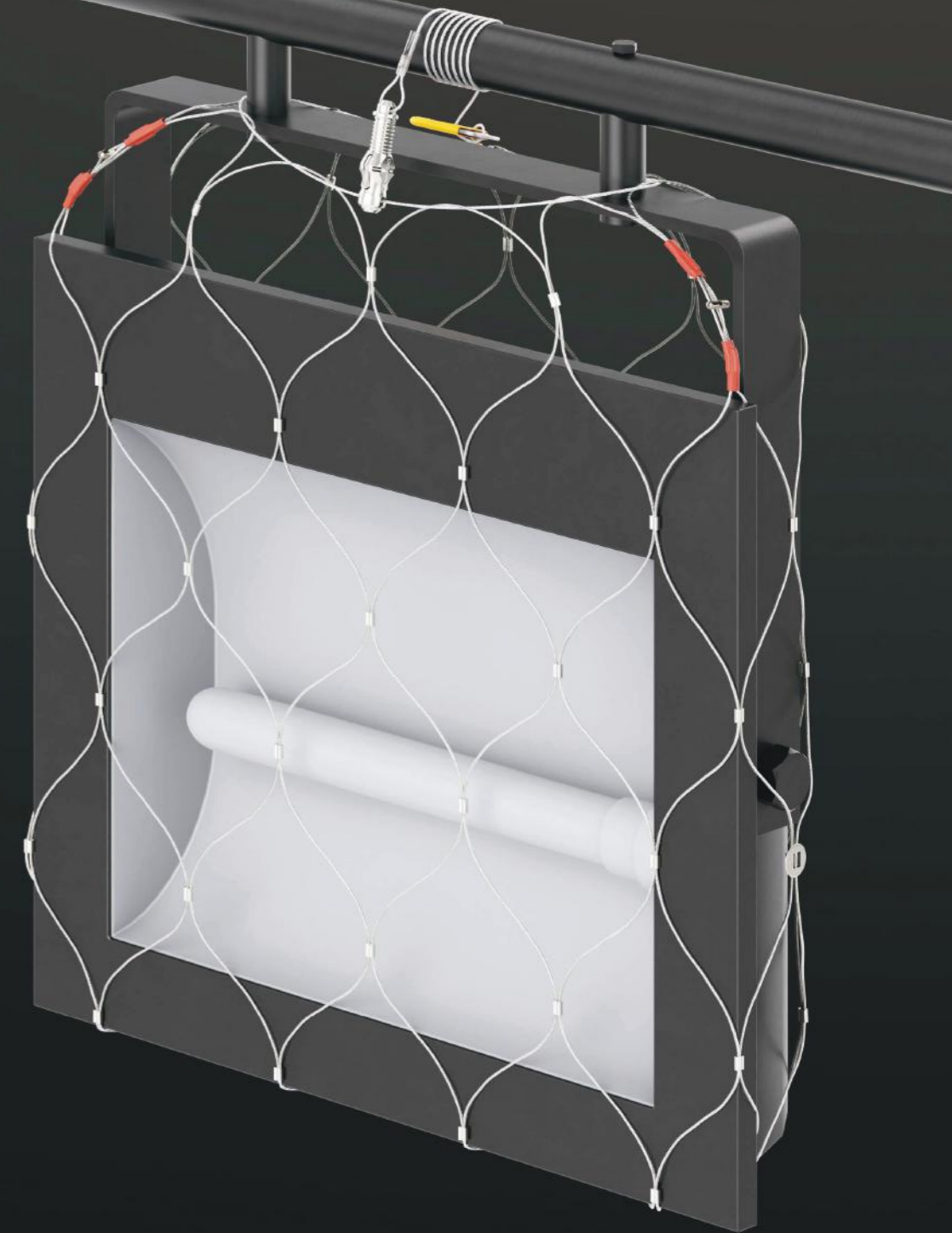

Enhanced Safety Features

The Trisafe™ Carabiner, another industry first for Dropsafe, is a revolutionary design that significantly reduces human error and eliminates the shortcomings of traditional carabiners. Advancing best practice, the Trisafe™ triple action opening, auto locking mechanism is easy to use with one hand, making the Net installation safer, faster and more intuitive.

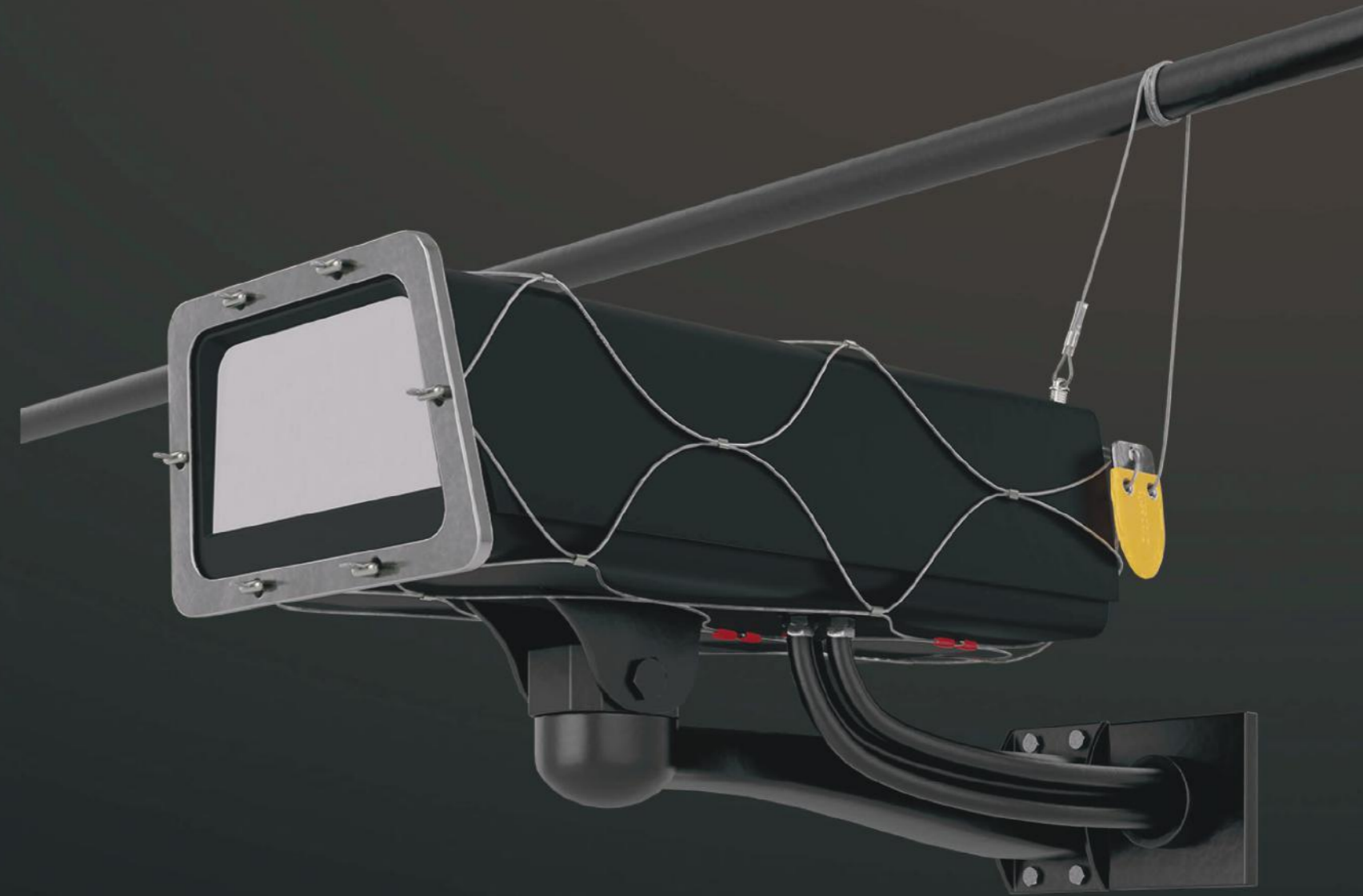
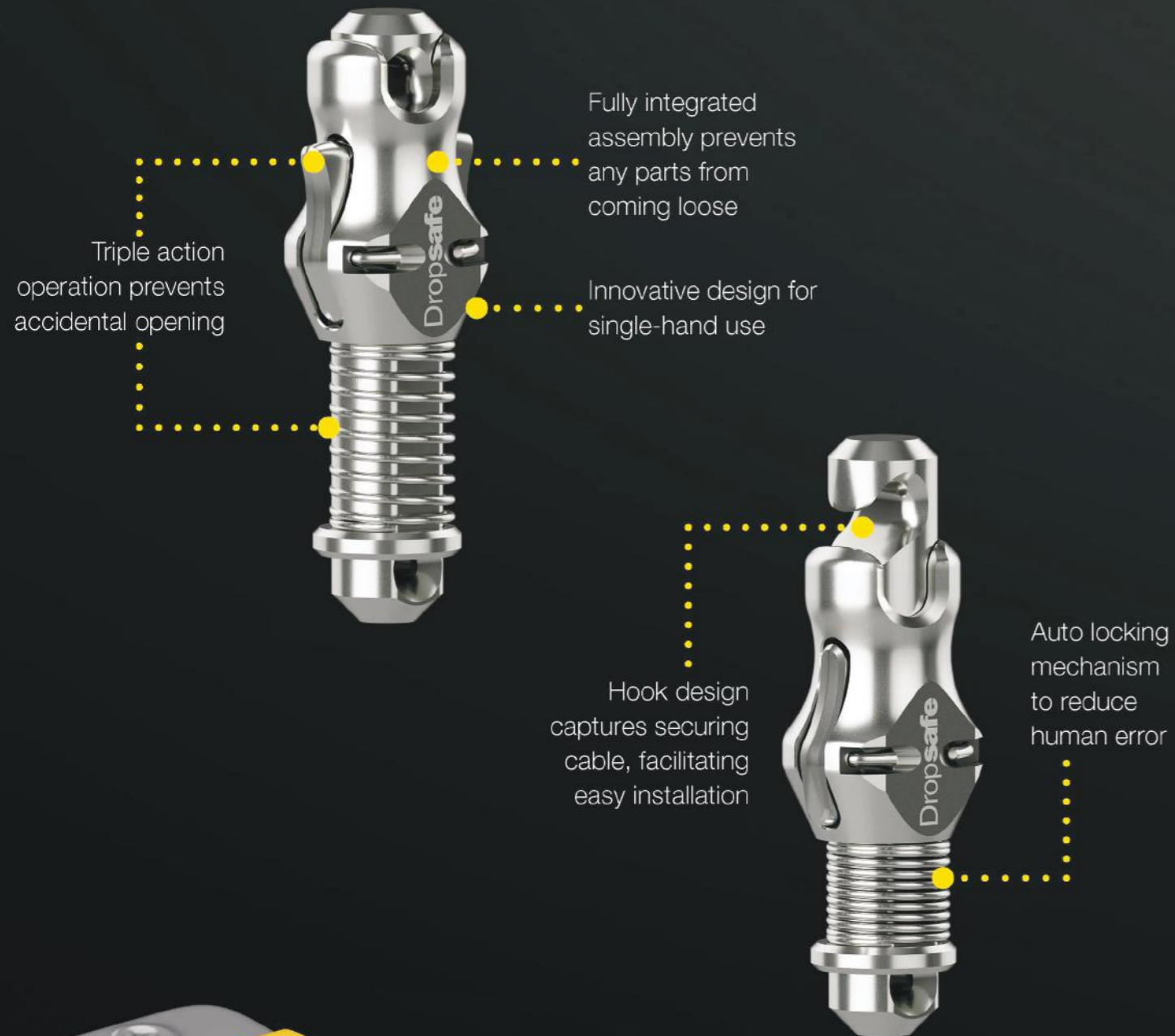

The Dropsafe Choke Plate has been updated to include an in-built RFID chip for improved traceability, more efficient and simpler inspection.

Many solutions are available to prevent fixtures at height from becoming dropped objects. It is vital that adequate secondary securing solutions are in place to ensure personnel safety. While safety slings do offer some protection, they do not fully enclose a fixture. Likewise, 'DIY' nets can cause a number of difficulties and, when being cut-to-size, create more dropped object risks than they prevent.

The new Dropsafe Nets are tested and certified to over 5x the Safe Working Load. With more than 100 sizes and installation toggles to ensure a snug fit, the Nets are all made from SUS 316 stainless steel. These features and the additional enhancements set a new safety standard for drops prevention.

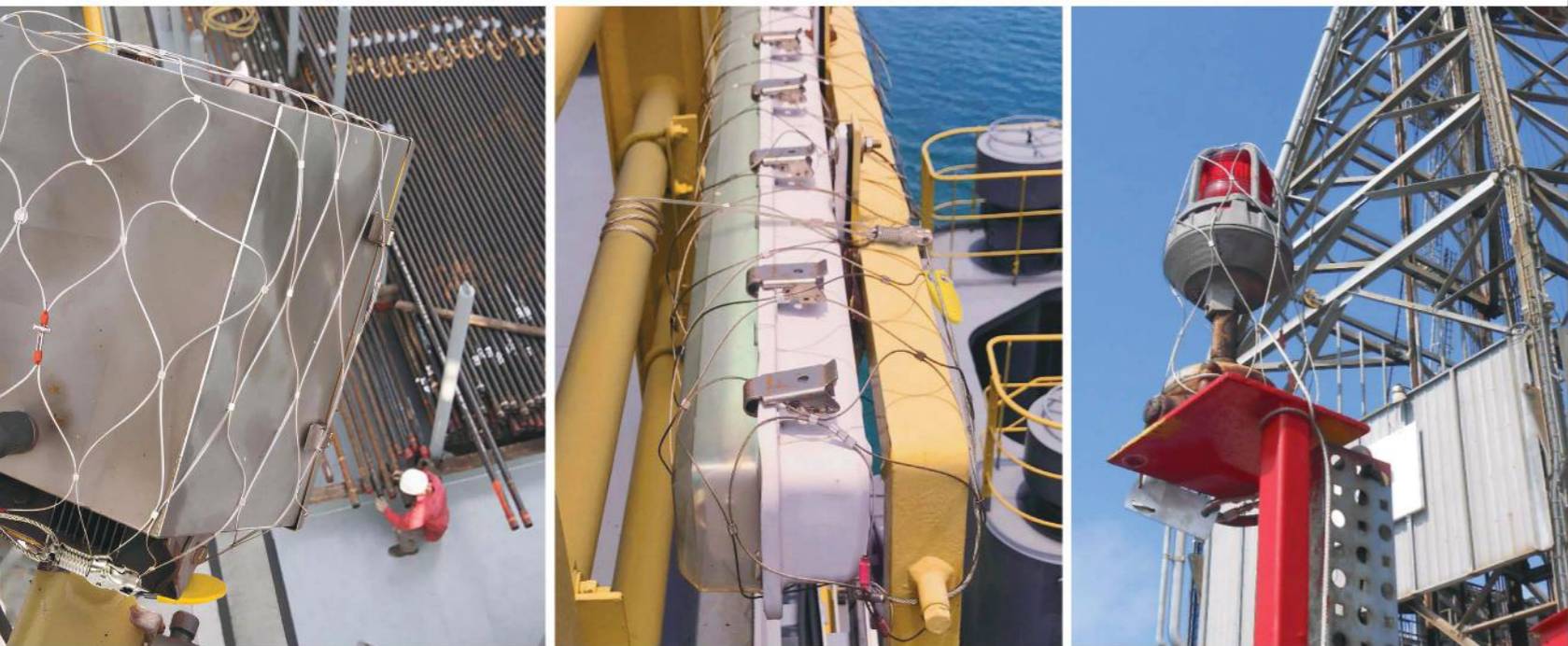

How The Dropsafe Net Works

The Dropsafe Net fully encloses the items being secured, with the advanced technology of the Dropsafe Choke Plate and Trisafe™ Carabiner. The RFID Choke Plate enables the integrated securing cable to tighten the Net firmly around the fixture, before wrapping around a secured structural attachment point. The cable then reconnects to the Dropsafe Net using the tripple action, auto locking features of the new Trisafe™, preventing the items from falling.

Features



Triple action auto locking Trisafe™ Carabiner



Toggles ensure a snug fit for all fixture shapes



Suitable for harsh environments



SUS/AISI 316 stainless steel wire and components



In-built RFID chip for improved traceability



Available in 100+ sizes (custom designs also available)



Designed and tested to over 5x Safe Working Load



ABS DOPP+ approved

Fixture types

Dropsafe Nets are designed and tested to fit a variety of fixture types.



Floodlights

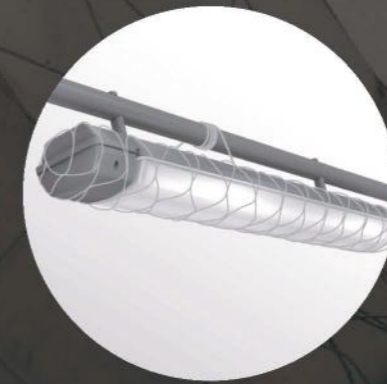

Fluorescent / LED Strip Lights



Nav / Strobe Lights

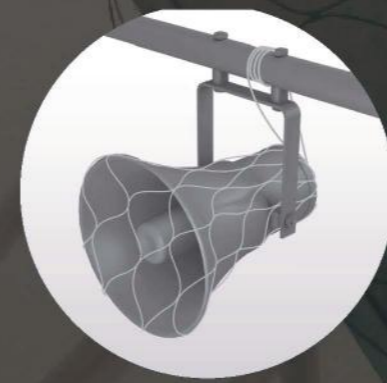

Speakers / Horns

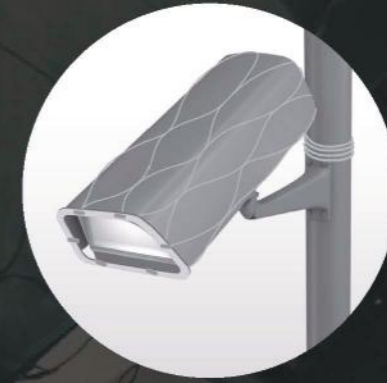

CCTV Cameras



Self-Retracting Lifelines

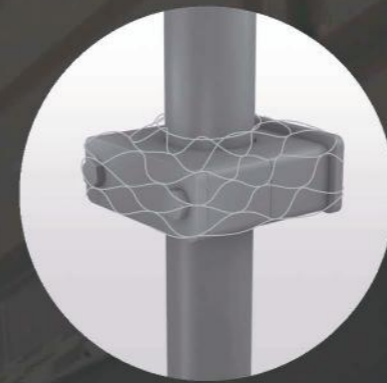

Pipe Clamps



Anodes

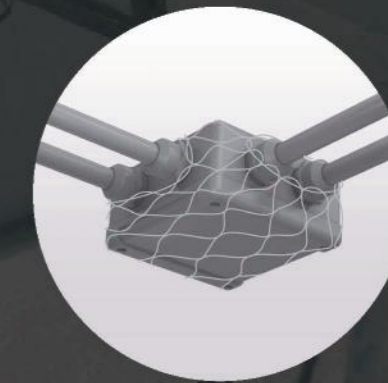

Junction Boxes, Heat, Smoke and CO2 Detectors

Dropsafe Slings

The Dropsafe Safety Sling range, made of SUS 316 stainless steel, offers a high standard of secondary securing for fixtures located at height. The Slings are specifically designed to withstand harsh environments, and provide an instant safety solution to prevent DROPS.

Tested and certified to over 5X the Safe Working Load, the Dropsafe Slings reduce human error. They boast a range of specific features, including the double ferrules at each end and an ID tag for increased traceability.

Benefits

- Provides an instant safety solution for your personnel
- Integrated safety features
- 3rd party tested & certified
- Quick & easy to install and inspect
- Fully recyclable

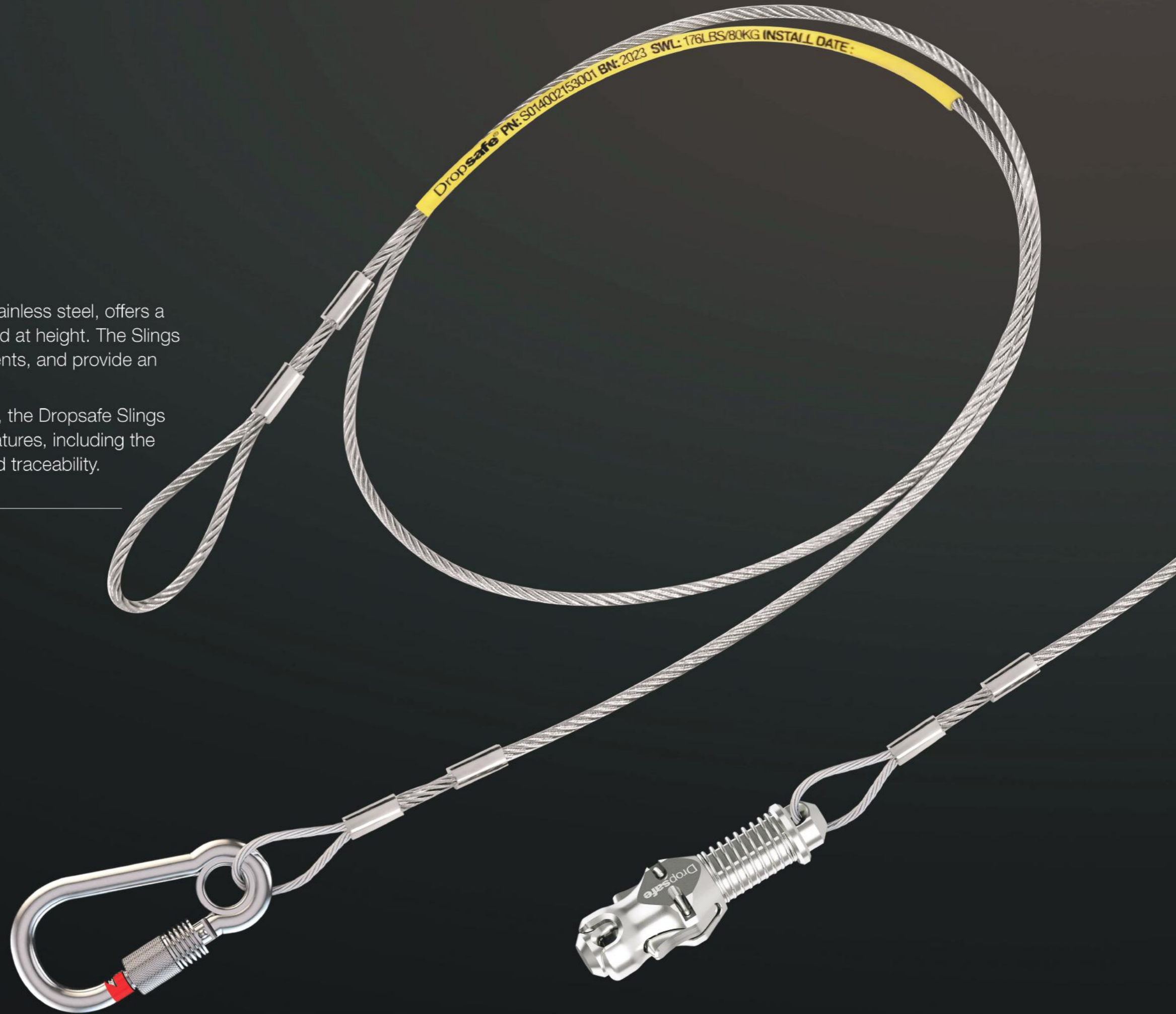

Trisafe™ Carabiner

Triple action operation prevents accidental opening

Auto locking mechanism to reduce human error

Innovative design for single-hand use

Captive eyelet keeps the sling loop positioned for convenient handling and safe loading

Screw Lock Carabiner

Visual indicator for easy inspection

Spring-loaded gate nut prevents screw lock coming loose

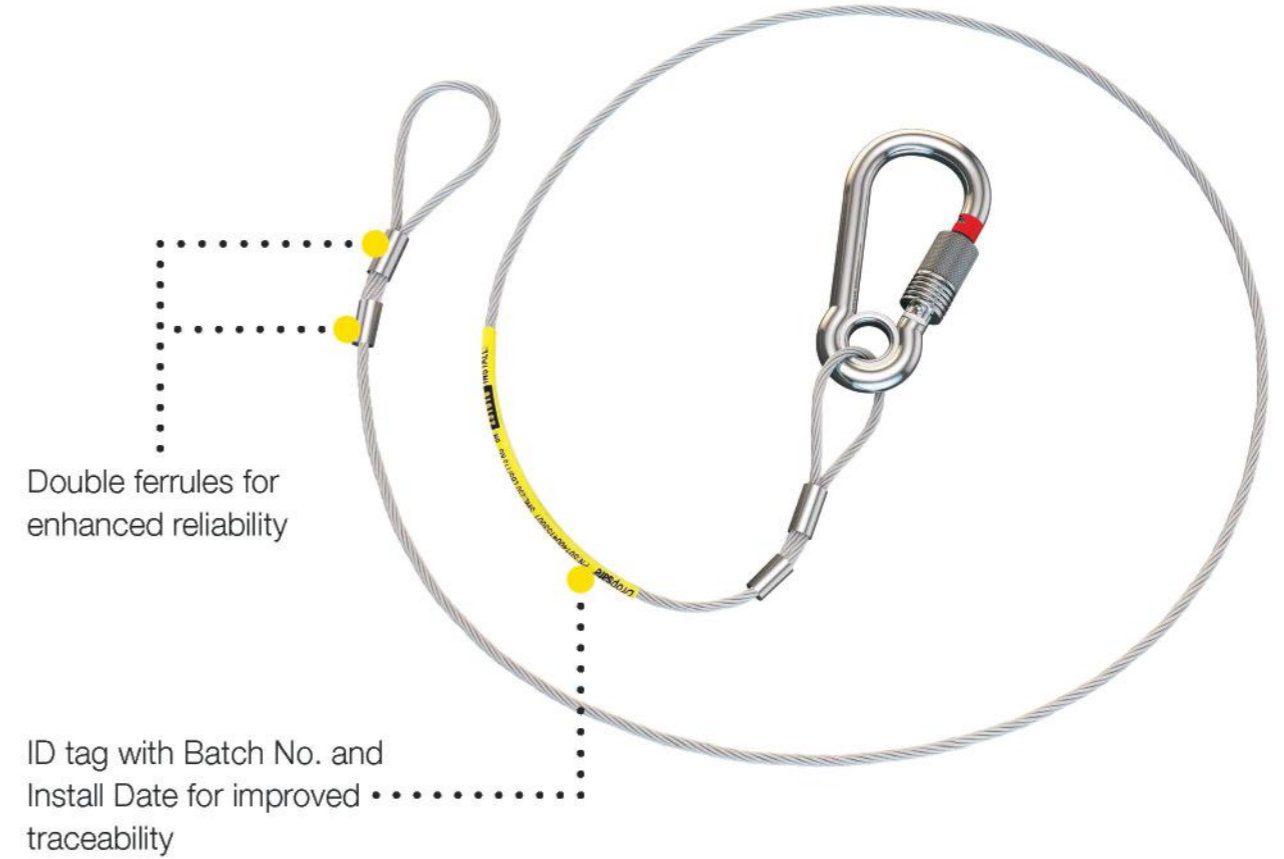

Features

- 316** SUS/AISI 316 stainless steel wire and components
- 5X SWL** Designed and tested to over 5x Safe Working Load
- Suitable for harsh environments
Fire and chemical resistant
- ID tag for improved traceability

- Triple action auto locking
Trisafe™ Carabiner - 316L
- Traditional Carabiner with spring-loaded gate nut available
- Fast & easy installation
no tools required
- ABS DOPP+ approved



Dropsafe Helideck Perimeter Safety Net

The Dropsafe Helideck Perimeter Safety Net system attaches to the existing helideck perimeter structure, preventing equipment and personnel from falling.

Designed and engineered to well exceed OGUK, CAP 437, and DNV GL standards and able to withstand a 2.3 kJ impact (100 kg at 2.35m).

The patented system is made from marine-grade stainless steel and is suitable for helidecks in any environment, delivering longevity, reliability, and low-cost ownership to the customer.

Benefits

- Advanced testing methodology – no drop tests required
- Fast & safe installation – free online training available
- Suitable for both steel & aluminium helidecks
- Easy inspection vs. PVC coated chain-link or synthetic nets
- Low-cost ownership
- Fully recyclable

How the Dropsafe Perimeter Safety Net works

On a helideck there are many factors that can create hazardous situations, such as high winds, helicopter downdraft and extreme weather conditions. The Dropsafe Helideck Perimeter Safety Net system and components are made of the highest quality, marine-grade stainless steel, to provide a durable and robust solution, which can withstand the harshest offshore environments. The patented system has been designed to be quickly and easily installed to the existing perimeter frame of any helideck, minimizing downtime.

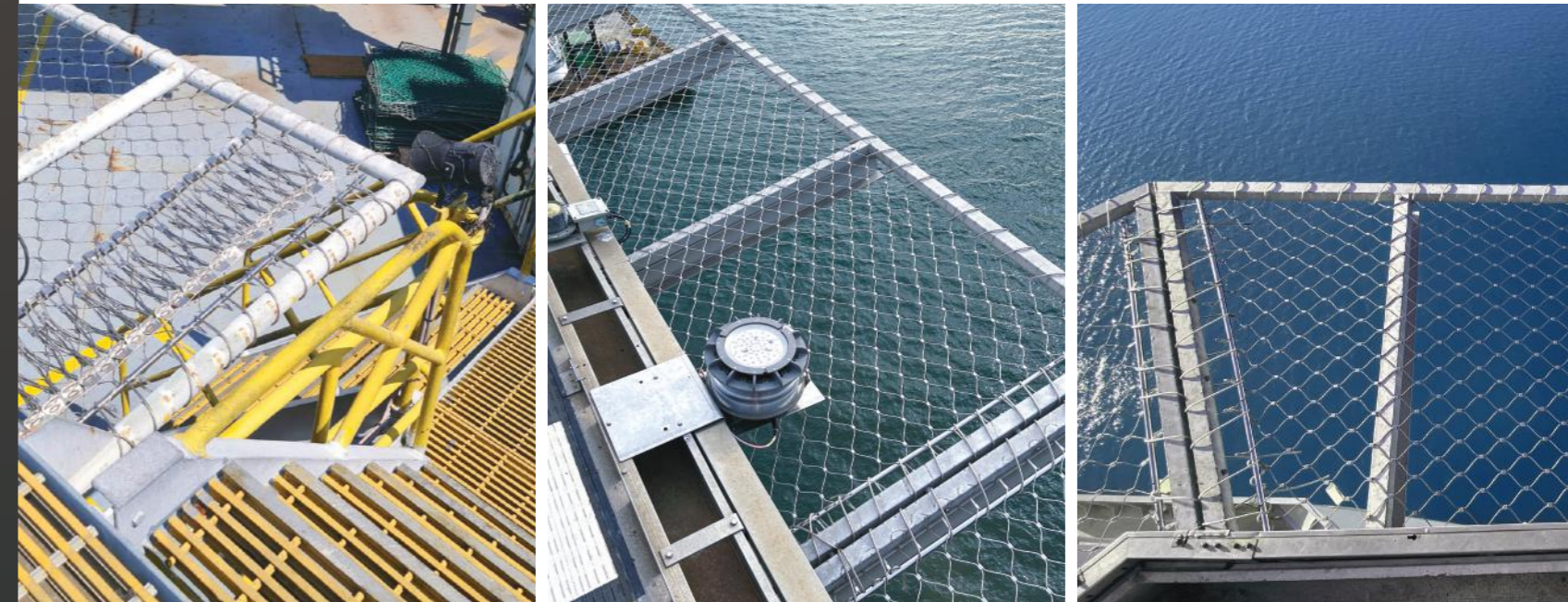

Coated wire used to secure the Net panel to the frame on both steel or aluminium helidecks

Durable SUS/AISI 316 stainless steel system, designed for harsh environments

Spreader bars included with each net panel to enable easy and efficient installation

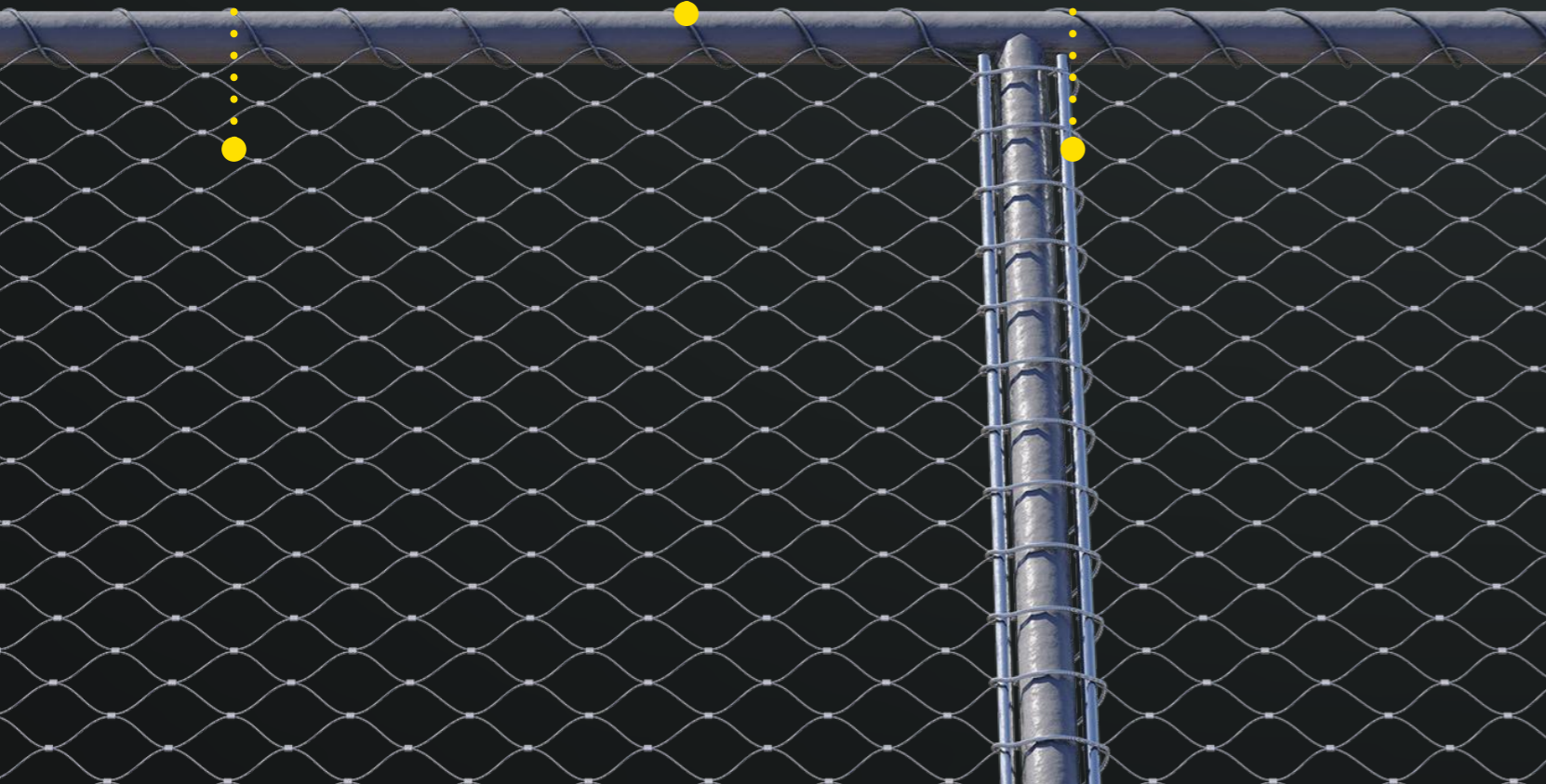

Where to use

The Dropsafe Helideck Perimeter Safety Net can be used as an effective solution to mitigate the risks of objects or personnel falling from a helideck or helipad. Ideal for all helidecks, including:

- Oil & Gas Rigs, Drill Ships & FPSOs
- Offshore Production & Accommodation Platforms
- Seismic, Cable Laying & Support Vessels
- Military/Defense
- Fire & Emergency Services/Search & Rescue
- Hospitals

Features



Exceeds CAP 437, OGUK, DNV & all global helideck standards



Full traceability and component serial numbering



Durable SUS/AISI 316 stainless steel system



Annual Testing Kit included for ongoing system testing



5-year warranty and 10+ year service life



Suitable for harsh environments



Fast & easy installation, technical support provided



ABS approved

Dropsafe Tethering

The Dropsafe Tethering solutions feature the world's first triple action, auto locking carabiner, specifically designed for securing tool (and equipment) use at height.

Our patented Trisafe™ technology is easy to use, ergonomic, and suitable for one handed glove operation, reducing the risk of human error and to prevent tools and other items from becoming dropped objects. Made from 100% stainless steel, the Trisafe™ is also easy to inspect and clean, giving it extended durability in the harshest environments.

The versatile range comes in a variety of different lengths, material types and functions depending on the type and weight of the tool, the application and/or user preference.



Benefits

- Prevents dropped tools and/or equipment
- Fast & easy to use – reduces human error
- Single-hand operation
- Easy to inspect & maintain
- Versatile
- Durable

Dropsafe Tethering Range

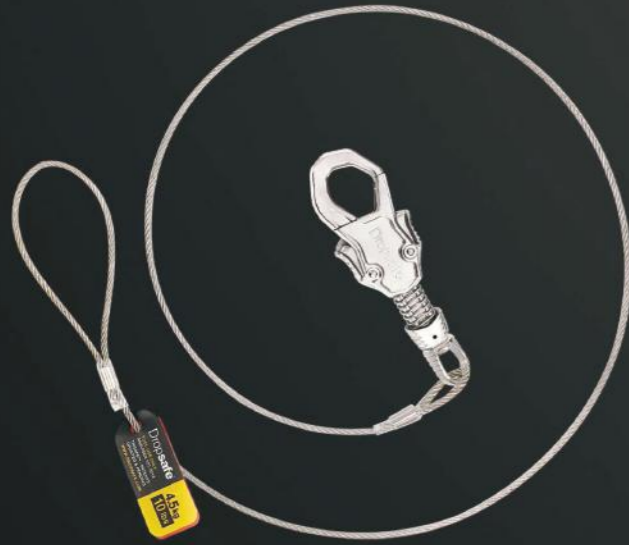

Wire Tool Lanyards



Wire Coil Tool Lanyards



Bungee Tool Lanyards



Webbing Tool Lanyards

Dropsafe Trisafe™ Carabiner

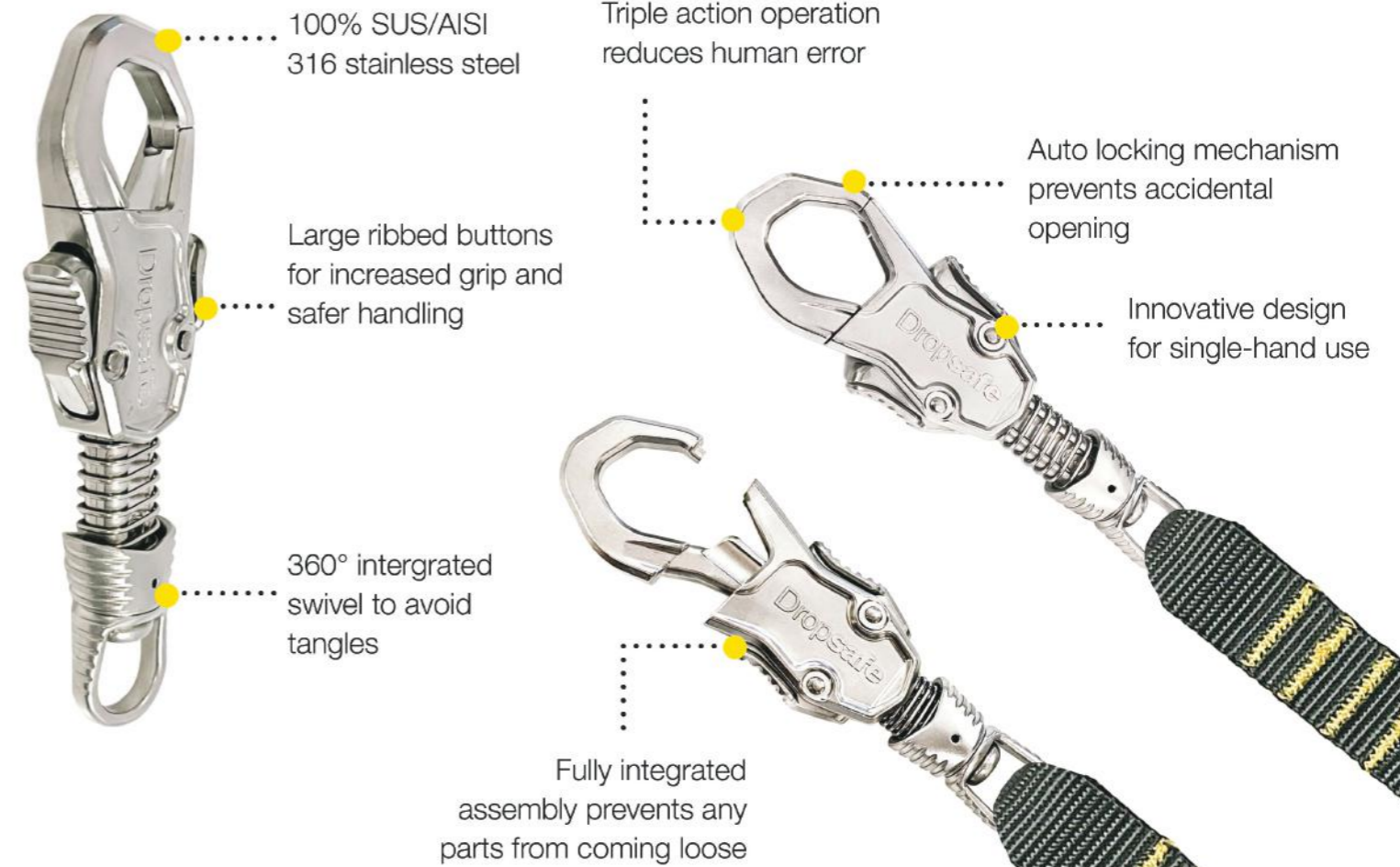

Features



Trisafe™ triple action, auto locking carabiner(s)



Designed for one-handed operation with gloves



360° integrated swivel avoids tangles



Variety of Lanyard types and attachment combinations



Third-party tested & compliant with international standards



Designed for harsh environments

Dropsafe Matting

The Dropsafe Matting is a PVC system for use on worksite walkways and flooring to stop objects falling through grating. Developed in partnership with Plastex, who have over 40 years' experience manufacturing high quality, durable matting. The two layer open grid construction prevents even small items dropping from walkways or platforms above, and the diamond cut pattern offers a high-traction, anti-slip surface.

The system is laid on walking working surfaces situated at height. It is strong and hardwearing, designed for use in harsh environments both on- and offshore. With high levels of resistance to both UV and chemical, oil and acid, the Dropsafe Matting system is the perfect addition to any industrial setting looking to elevate their safety programme.

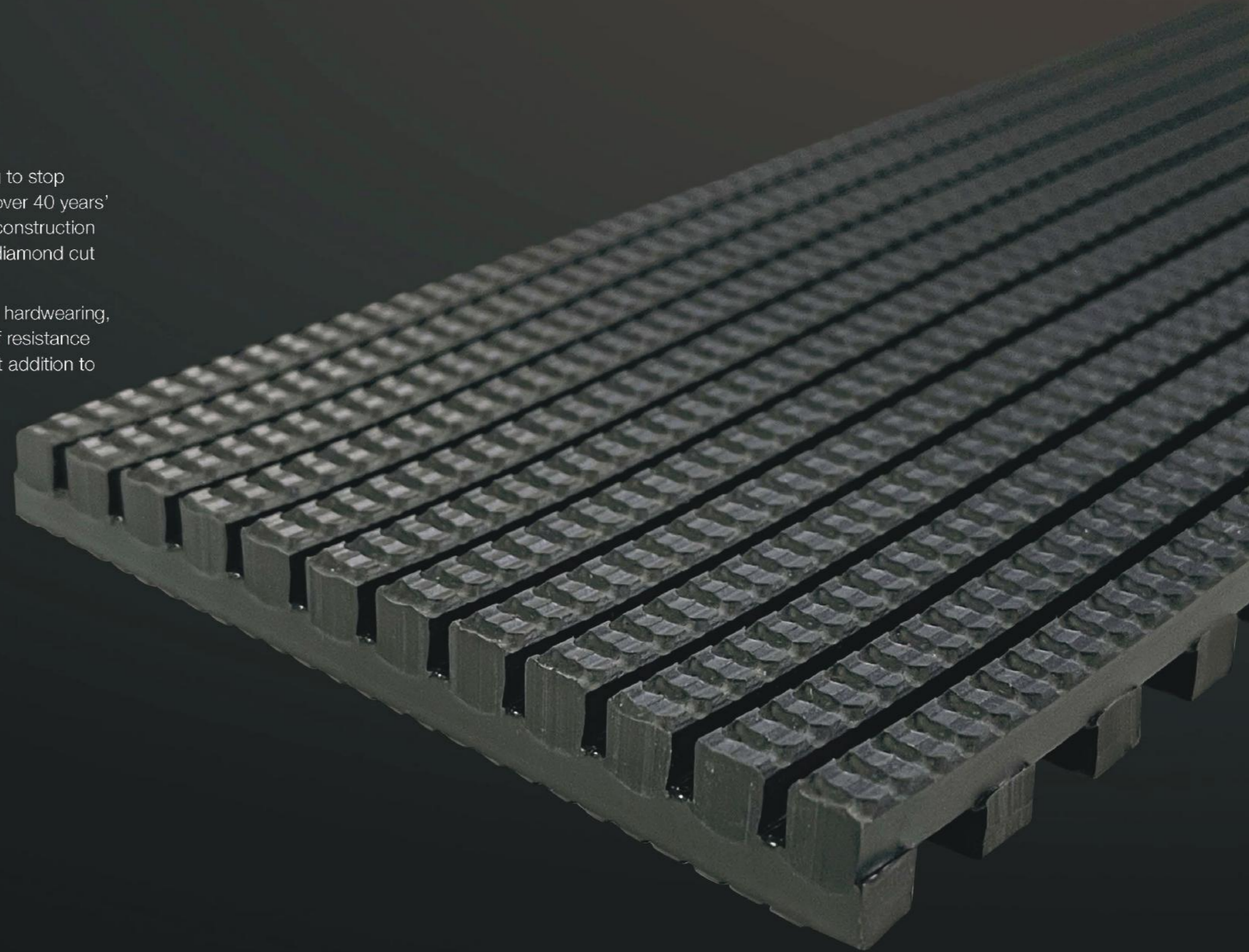

Benefits

- Durable and hard-wearing
- Two-layer grid prevents small items from dropping
- Proven anti-fatigue properties
- Variety of colours and thicknesses available
- Excellent drainage ability
- Made from recycled material and 100% recyclable

Diamond cut pattern creates high level anti-slip properties

Modules come with factory fitted edging to fit snugly against walkway perimeters

Supplied in a variety of roll sizes, easy to cut to size on site

Open grid construction makes for easy cleaning with high pressure hose



Where to use

The Dropsafe Matting is an easily-customisable PVC covering for flooring, helping to elevate worksite safety.

- Walkways & stairways
- Platforms & catwalks
- Grated flooring
- Permanent or temporary structures
- Indoor or outdoor applications

Features



Made from non-porous PVC



Certified slip resistant



Chemical, oil & acid resistant



Contours to uneven surfaces



High UV resistance
Suitable for harsh environments



4-year warranty

Dropsafe Pouches

The Dropsafe Pouches are safety devices designed to secure handheld items used at height such as two-way radios, portable gas detectors, aerosol spray cans and multimeters.

The Pouch fully encloses the item being secured and tethers it to the user, preventing it from becoming a dropped object hazard.

Benefits

- Instant safety solution
- Fully encloses and tethers item being secured
- Products available to fit a variety of handheld items
- Fully recyclable



316 stainless steel wire and components

Fully enclosed and tethers item being secured

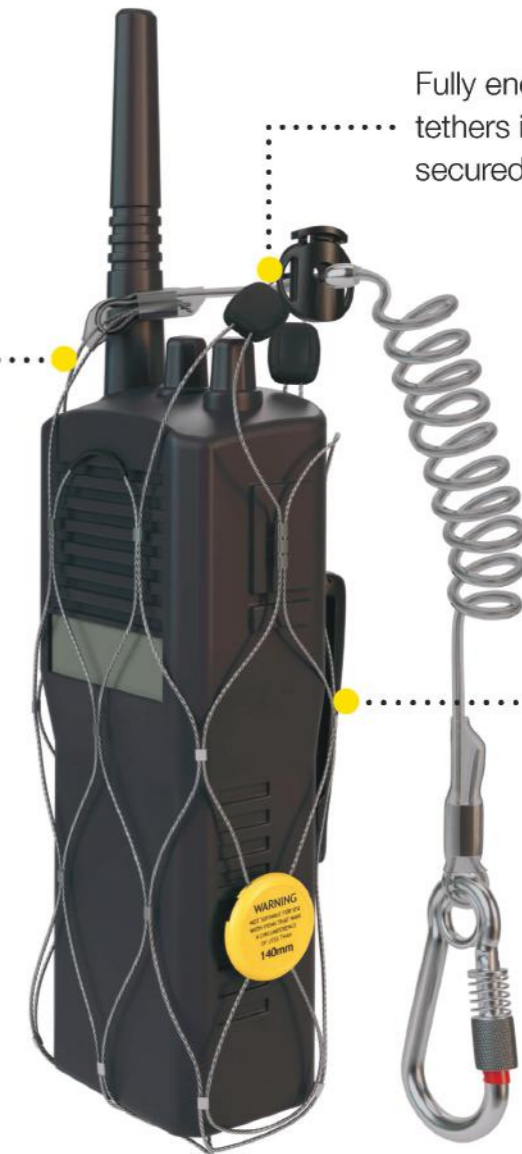

TPU coated wire ensures scratch resistance

Where to use

All areas where work or access is required at height, where single handed use of an item is required and there is risk of dropping, damaging or losing an item.

Features



SUS/AISI 316 stainless steel wire and components



Comes with heavy duty belt clip



Designed and tested to over 2x Safe Working Load



Available in a range of sizes (custom designs also available)

Dropsafe Barricade

The Dropsafe Barricade is a work site safety management system.

The Barricade is the only versatile and fully customisable system designed to install in any type of access and work area.

The Barricade system's flexibility enables good housekeeping practices, providing a safer working environment for your personnel.

Benefits

- Modular design provides flexibility and adheres to good housekeeping practices
- Effective solution to reinforce and enhance onsite safety procedures
- Instant safety solution with no tools required

How the Dropsafe Barricade works

The Barricade is designed to allow for modular use as lengths and sections can be fully customised making the system quick and easy to deploy. The flexible polymer chain allows the interconnected links to be easily detached and reattached by hand to suit the distance of the cordoned area with no excess chain or wastage.

The system incorporates a polymer chain, attachable warning signs as well as a waterproof reflective pouch for displaying workplace safety documentation.

Where to use

The Dropsafe Barricade can be used as an effective temporary control to minimise risk to personnel around machinery within areas of operation such as:

- Pressure testing
- Open hatches
- Overhead lifting operations
- Drill floor access/egress
- Maintenance work overhead
- Maintenance work – deck Level
- Anchor handling
- Hot works



Features



Suitable for harsh environments



Attachable DANGER and CAUTION signs



Durable weatherproof and reflective document pouch



Magnetic hooks to connect the chain to metal structures



Customisable chain length and multiple installation options

All statements and information made in this brochure are for information purposes only. Dropsafe makes no representations or warranties of any kind (express or implied) about the completeness of the information or the suitability of the product for specific needs. Dropsafe assumes no liability for any losses or damage resulting from any reliance or dependence on the published information. Dissemination of any information contained in this brochure is prohibited. Dropsafe reserves the right to add and remove or amend products to its line at any time, and the reader should check for updates on our website.



Protecting Your People

The Americas

☎ +1 866 299 2294
✉ america@dropsafe.com

Asia

☎ +852 3664 8350
✉ asia@dropsafe.com

Europe

☎ United Kingdom +44 0800 015 9709
☎ The Netherlands +31 0800 022 8621
✉ europe@dropsafe.com

Middle East & Africa

☎ +971 4 328 4855
✉ middleeast@dropsafe.com

Oceania

☎ +61 1800 821 649
✉ australia@dropsafe.com

Dropsafe is a proud member of:



Dropsafe®

Drops Prevention Technology